

### Features

- Glass Passivated Die Construction
- Super-Fast Switching for High Efficiency
- Surge Overload Rating to 30A Peak
- Low Reverse Leakage Current
- Lead Free Finish, RoHS Compliant (Note 4)**

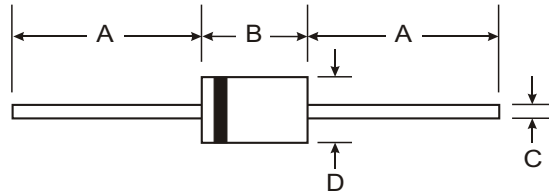

### Mechanical Data

- Case: DO-41
- Case Material: Molded Plastic. UL Flammability Classification Rating 94V-0
- Moisture Sensitivity: Level 1 per J-STD-020C
- Terminals: Finish - Tin. Plated Leads Solderable per MIL-STD-202, Method 208 (e3)
- Polarity: Cathode Band
- Marking: Type Number
- Ordering Information: See Last Page
- Weight: 0.3 grams (approximate)

DO-41		
Dim	Min	Max
A	25.40	
B	4.06	5.21
C	0.71	0.864
D	2.00	2.72
All Dimensions in mm		

### Maximum Ratings and Electrical Characteristics @ T<sub>A</sub> = 25 C unless otherwise specified

Single phase, half wave, 60Hz, resistive or inductive load.  
For capacitive load, derate current by 20%.

Characteristic	Symbol	SF10 AG	SF10 BG	SF10 CG	SF10 DG	SF10 FG	SF10 GG	SF10 HG	SF10 JG	Unit	
Peak Repetitive Reverse Voltage Working Peak Reverse Voltage DC Blocking Voltage (Note 5)	$V_{RRM}$ $V_{RWM}$ $V_R$	50	100	150	200	300	400	500	600	V	
RMS Reverse Voltage	$V_{R(RMS)}$	35	70	105	140	210	280	350	420	V	
Average Rectified Output Current @ T <sub>A</sub> = 75 C (Note 1)	I <sub>O</sub>	1.0								A	
Non-Repetitive Peak Forward Surge Current 8.3ms Single half sine-wave Superimposed on Rated Load	I <sub>FSM</sub>	30								A	
Forward Voltage @ I <sub>F</sub> = 1.0A	V <sub>FM</sub>	0.95			1.3		1.5			V	
Peak Reverse Current @ T <sub>A</sub> = 25 C at Rated DC Blocking Voltage (Note 5) @ T <sub>A</sub> = 100 C	I <sub>RM</sub>	10				100					A
Reverse Recovery Time (Note 3)	t <sub>rr</sub>	35			40		50			ns	
Typical Total Capacitance (Note 2)	C <sub>T</sub>	75						50			pF
Thermal Resistance Junction to Ambient	R <sub>JA</sub>	75								°C/W	
Operating and Storage Temperature Range	T <sub>j</sub> , T <sub>STG</sub>	-65 to +150								C	

- Notes:
1. Valid provided that leads are maintained at ambient temperature at a distance of 9.5mm from the case.
  2. Measured at 1.0MHz and applied reverse voltage of 4.0V DC.
  3. Measured with I<sub>F</sub> = 0.5A, I<sub>R</sub> = 1.0A, I<sub>rr</sub> = 0.25A. (See Figure 5)
  4. RoHS revision 13.2.2003. Glass and high temperature solder exemptions applied, see EU Directive Annex Notes 5 and 7.
  5. Short duration pulse test used to minimize self-heating effect

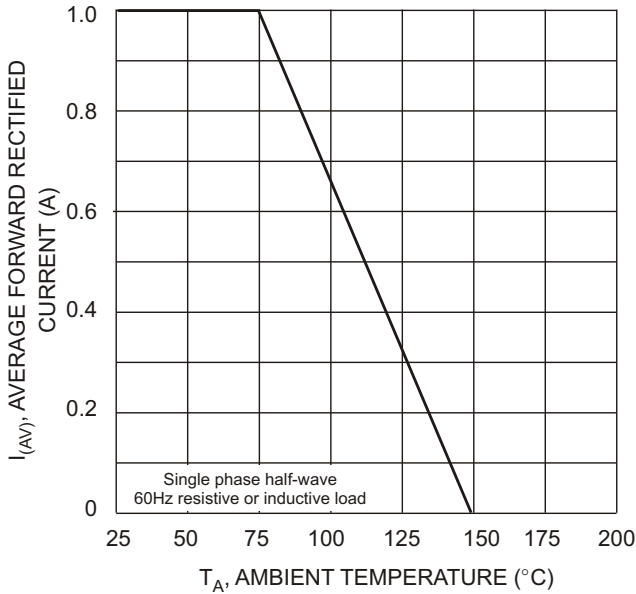

Fig. 1 Forward Current Derating Curve

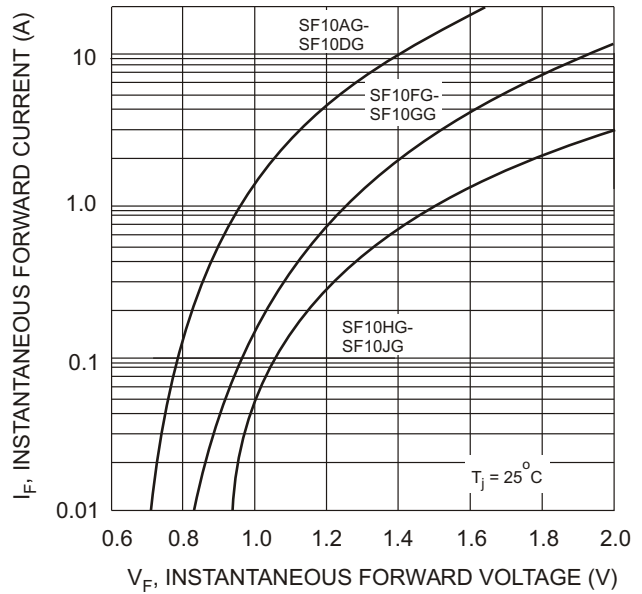

Fig. 2 Typical Forward Characteristics

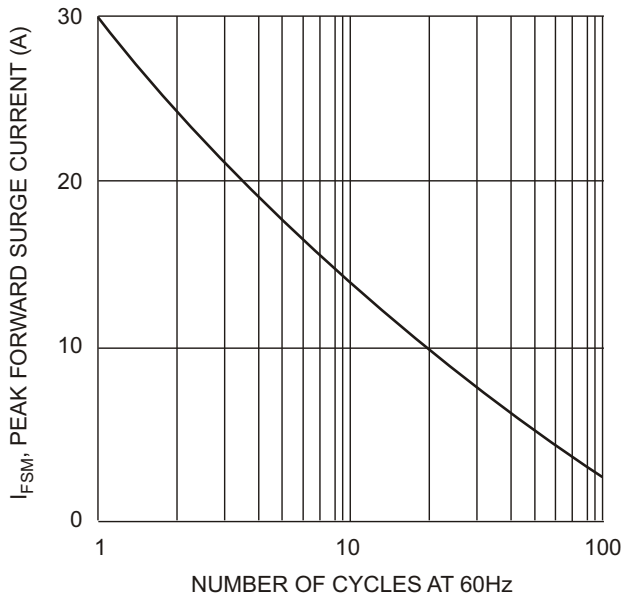

Fig. 3 Peak Forward Surge Current

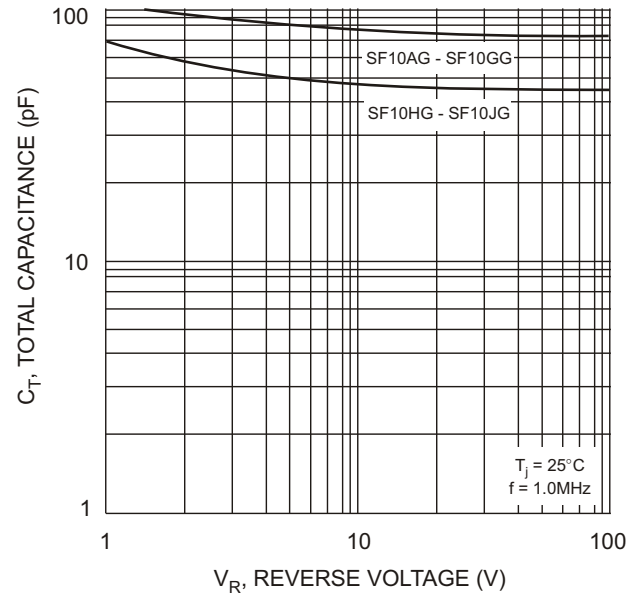
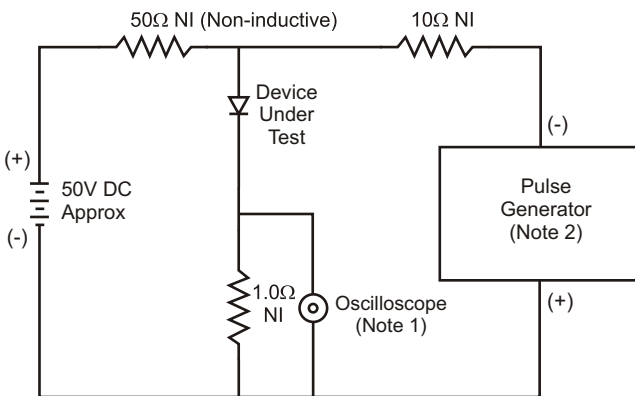
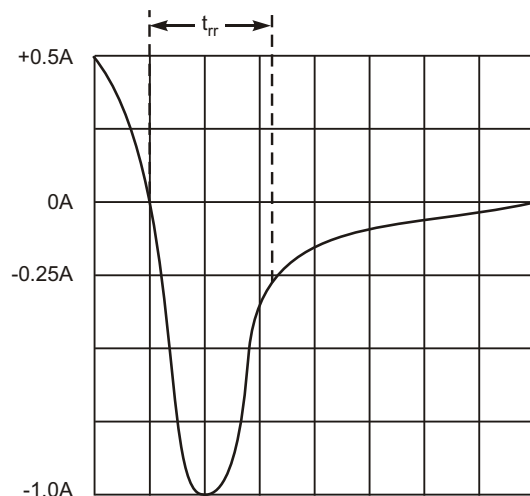

Fig. 4 Typical Total Capacitance



- Notes:  
 1. Rise Time = 7.0ns max. Input Impedance = 1.0MΩ, 22pF.  
 2. Rise Time = 10ns max. Input Impedance = 50Ω.



Set time base for 50/100 ns/cm

Fig. 5 Reverse Recovery Time Characteristic and Test Circuit

## Ordering Information (Note 6)

Device	Packaging	Shipping
SF10AG-A	DO-41	5K/Ammo Pack
SF10AG-B	DO-41	1K/Bulk
SF10AG-T	DO-41	5K/Tape & Reel, 13-inch
SF10BG-A	DO-41	5K/Ammo Pack
SF10BG-B	DO-41	1K/Bulk
SF10BG-T	DO-41	5K/Tape & Reel, 13-inch
SF10CG-A	DO-41	5K/Ammo Pack
SF10CG-B	DO-41	1K/Bulk
SF10CG-T	DO-41	5K/Tape & Reel, 13-inch
SF10DG-A	DO-41	5K/Ammo Pack
SF10DG-B	DO-41	1K/Bulk
SF10DG-T	DO-41	5K/Tape & Reel, 13-inch
SF10FG-A	DO-41	5K/Ammo Pack
SF10FG-B	DO-41	1K/Bulk
SF10FG-T	DO-41	5K/Tape & Reel, 13-inch
SF10GG-A	DO-41	5K/Ammo Pack
SF10GG-B	DO-41	1K/Bulk
SF10GG-T	DO-41	5K/Tape & Reel, 13-inch
SF10HG-A	DO-41	5K/Ammo Pack
SF10HG-B	DO-41	1K/Bulk
SF10HG-T	DO-41	5K/Tape & Reel, 13-inch
SF10JG-A	DO-41	5K/Ammo Pack
SF10JG-B	DO-41	1K/Bulk
SF10JG-T	DO-41	5K/Tape & Reel, 13-inch

Notes: 6. For packaging details, visit our website at <http://www.diodes.com/datasheets/ap02008.pdf>.

### IMPORTANT NOTICE

Diodes Incorporated and its subsidiaries reserve the right to make modifications, enhancements, improvements, corrections or other changes without further notice to any product herein. Diodes Incorporated does not assume any liability arising out of the application or use of any product described herein; neither does it convey any license under its patent rights, nor the rights of others. The user of products in such applications shall assume all risks of such use and will agree to hold Diodes Incorporated and all the companies whose products are represented on our website, harmless against all damages.

### LIFE SUPPORT

Diodes Incorporated products are not authorized for use as critical components in life support devices or systems without the expressed written approval of the President of Diodes Incorporated.